

Datasheet of SAW Duplexer 1612 Band2 Unbalanced

KYOCERA Part No. : SD16-1880R8UUA1

KYOCERA Corporation
All rights reserved

Rating

Items	Rating	Unit	Note	
Operating Temperature Range	-30 to +85	deg.C		
Storage Temperature Range	-40 to +85	deg.C		
Max Input Power	Tx Band	+30	dBm	5,000Hours,CW,Ta=50deg.C
		+30	dBm	5,000Hours,QPSK,LTE,Ta=50deg.C
		+30	dBm	5,000Hours,DFT-s-OFDM-QPSK,Ta=50deg.C
		+28.5	dBm	5,000Hours,CP-OFDM-QPSK,Ta=50deg.C
ESD Level	Machine Model	50	Volt	Complied to JESD22-A115
Moisture Sensitivity Level		3	-	Complied to J-STD-033B.1
Tx Port Nominal Impedance	50+1.6nH	ohm	Unbalance	
Ant. Port Nominal Impedance	50//5.4nH	ohm	Unbalance	
Rx Port Nominal Impedance	50//24nH	ohm	Unbalance	

Dimensions

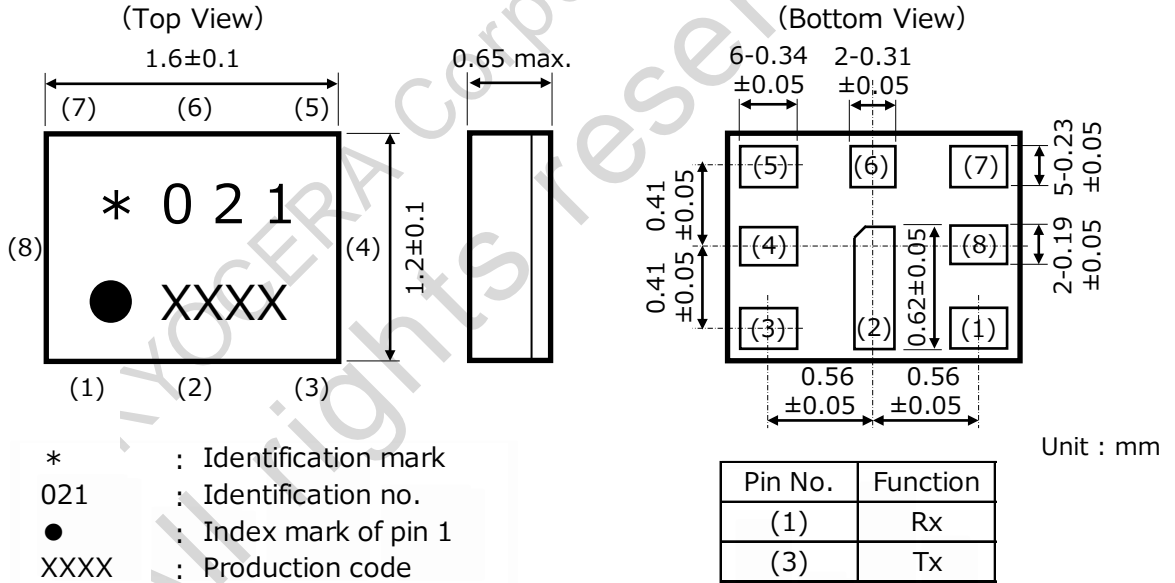

Recommendable Land Pattern

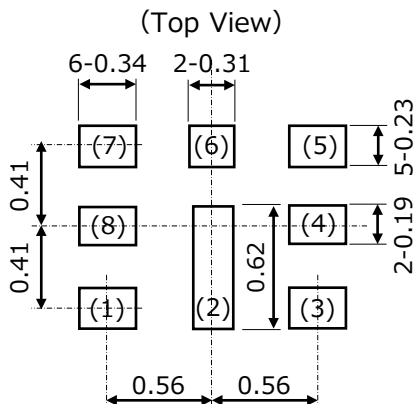

Measurement Circuit

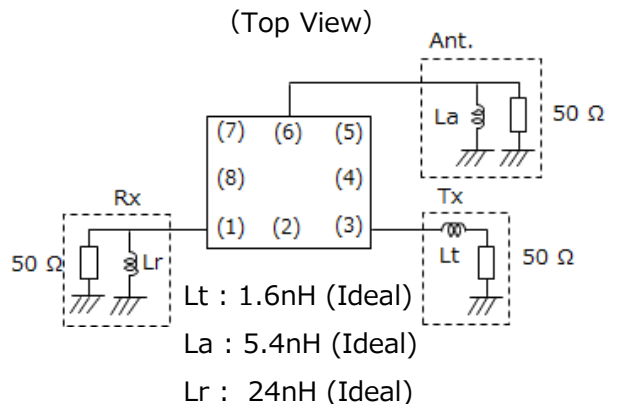

Electrical Characteristics

ITEMS		Frequency [MHz]	Unit	Specification			Notes	
				min.	typ.	max.		
Tx to Ant	Insertion Loss	1850 - 1910	dB	-	1.8	2.5	B2 TX	
	Amplitude Ripple	1850 - 1910	dB	-	1.0	2.2	B2 TX	
	VSWR	Ant	1850 - 1910	-	-	1.3	2.0	B2 TX
		Tx	1850 - 1910	-	-	1.4	2.0	B2 TX
	Attenuation	10 - 960	dB	30	44	-		
		1166 - 1187	dB	25	41	-	GPS L5	
		1225 - 1250	dB	30	41	-	GPS L2	
		1559 - 1606	dB	30	42	-	GNSS	
		1930 - 1990	dB	40	53	-	B2 RX	
		2110 - 2200	dB	30	39	-	B66 RX	
		2400 - 2500	dB	25	45	-	Bluetooth	
		2496 - 2690	dB	25	33	-	B41	
		3700 - 3820	dB	20	26	-	2H	
	4400 - 5730	dB	15	22	-	5G		
Ant to Rx	Insertion Loss	1930 - 1990	dB	-	2.1	3.0	B2 RX	
	Amplitude Ripple	1930 - 1990	dB	-	1.3	2.8	B2 RX	
	VSWR	Ant	1930 - 1990	-	-	1.5	2.0	B2 RX
		Rx	1930 - 1990	-	-	1.4	2.0	B2 RX
	Attenuation	10 - 960	dB	40	45	-		
		1710 - 1830	dB	40	43	-	B66 TX	
		1850 - 1910	dB	40	50	-	B25 TX	
		2300 - 2400	dB	25	42	-	B2 TX	
		2400 - 2500	dB	25	39	-	Bluetooth	
		2496 - 2690	dB	25	41	-	B41	
		3780 - 3900	dB	40	53	-	2H	
4400 - 5950		dB	20	50	-	5G		
5630 - 5810	dB	30	50	-				
Tx to Rx	Isolation	1850 - 1910	dB	55	60	-		
		1930 - 1990	dB	53	57	-	@-20 to +85deg.C	
		1930 - 1990	dB	51	57	-		

Electrical Characteristics

[Tx to Ant]

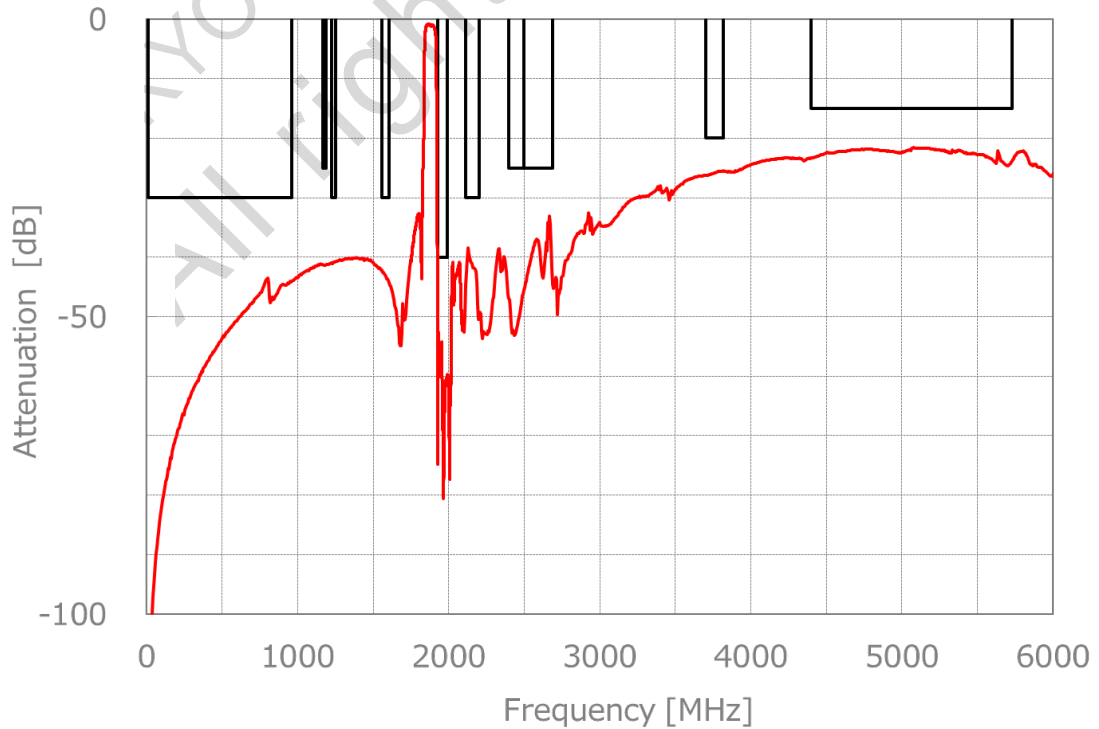
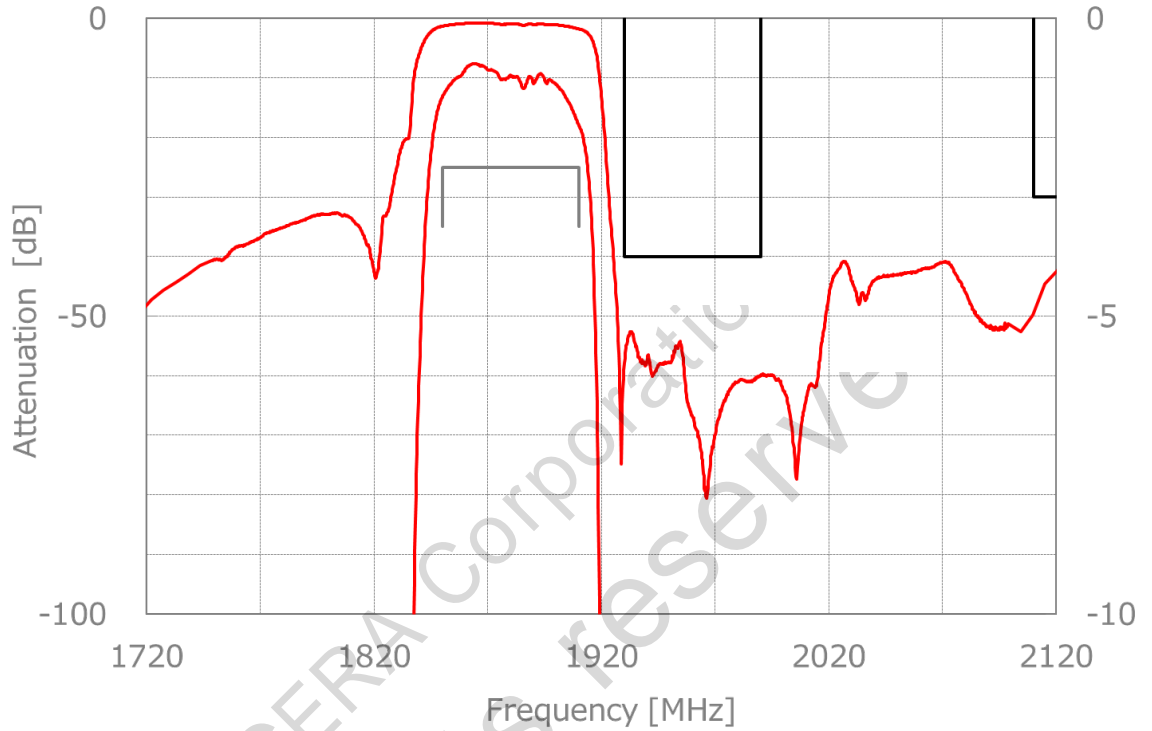

Electrical Characteristics

[Ant to Rx]

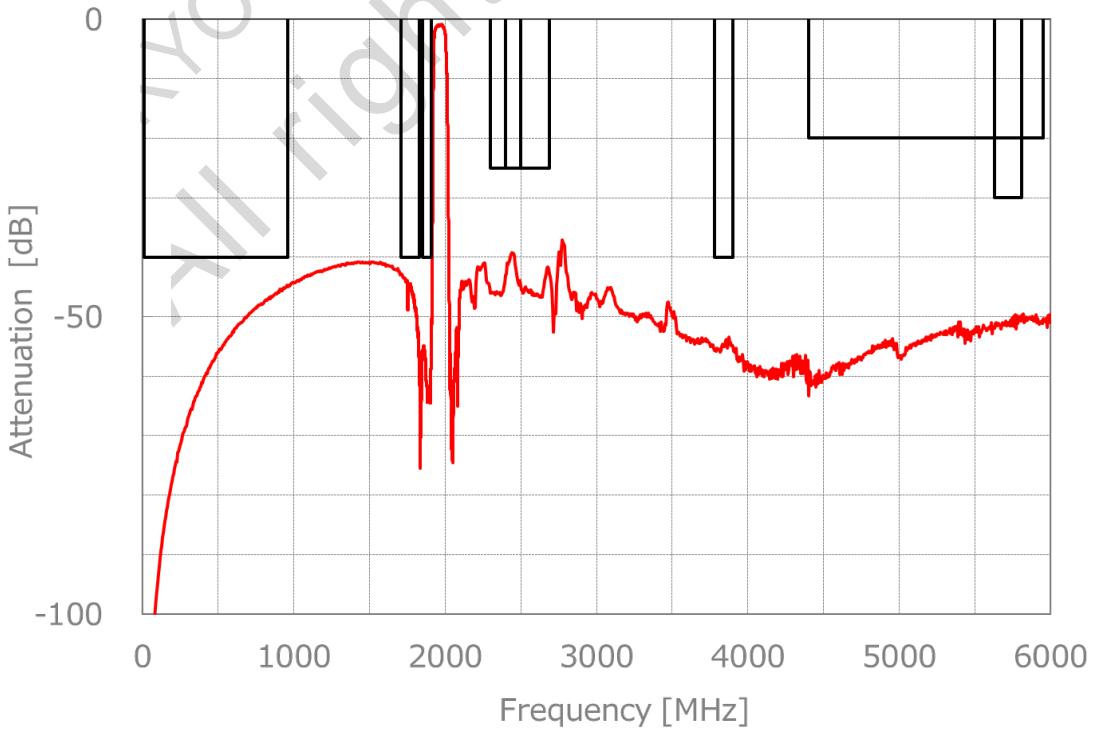
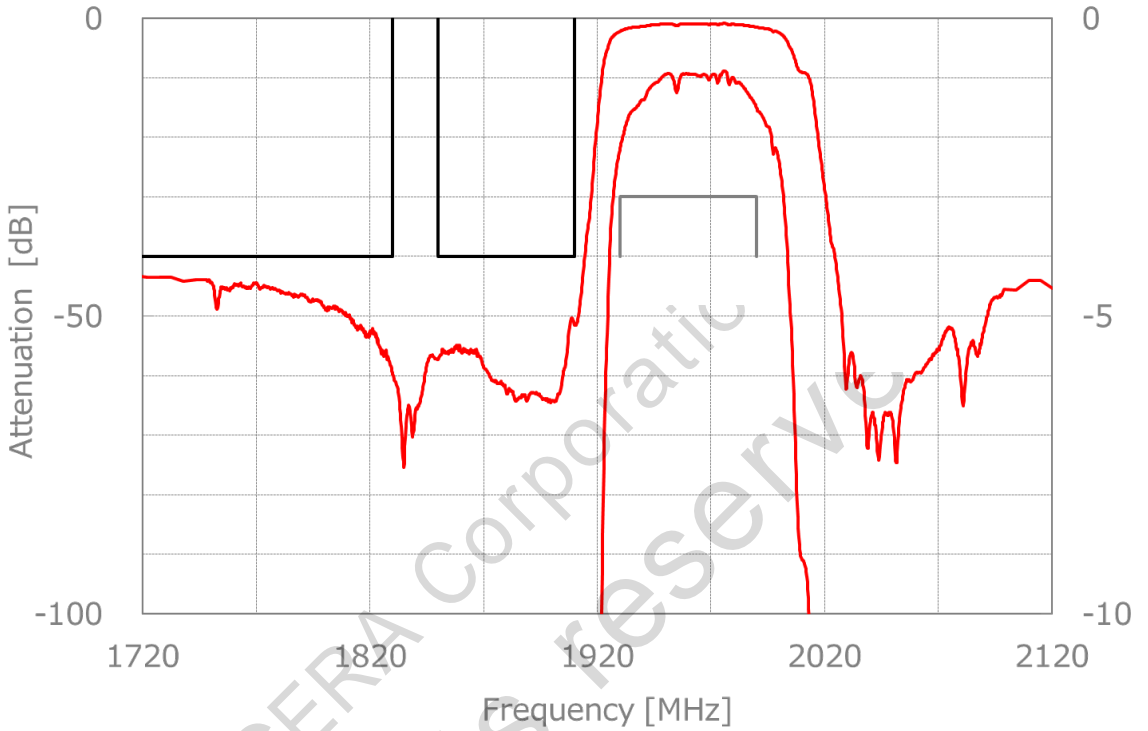

Electrical Characteristics

[Tx to Rx]

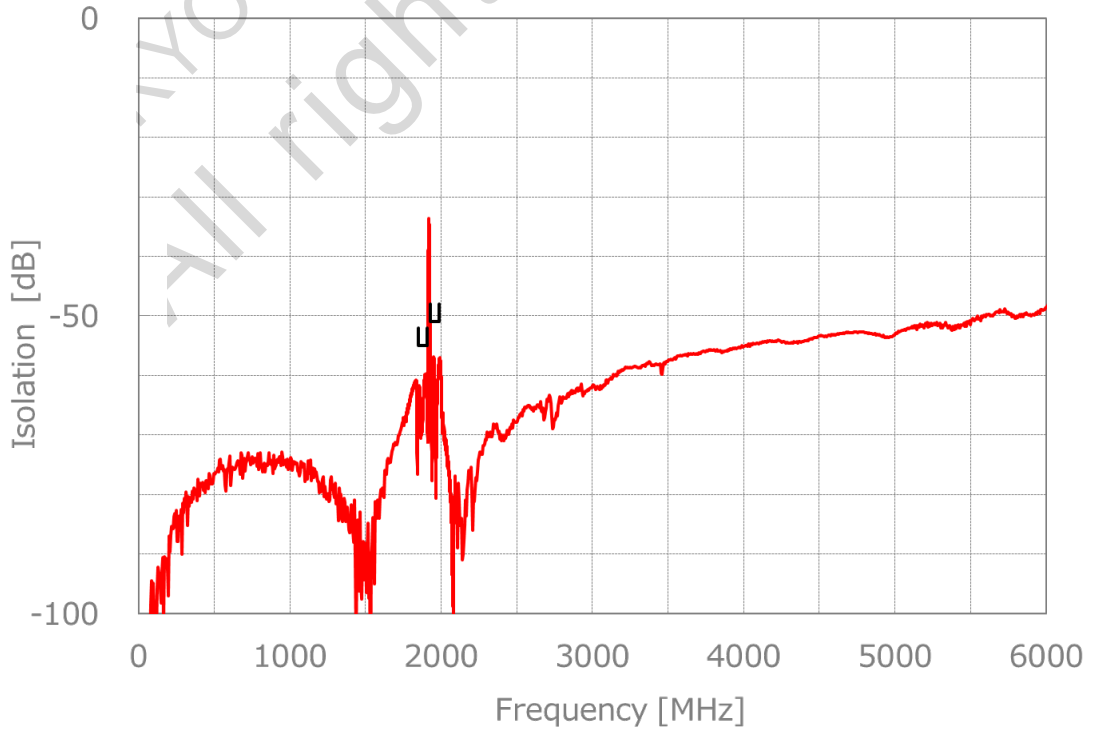
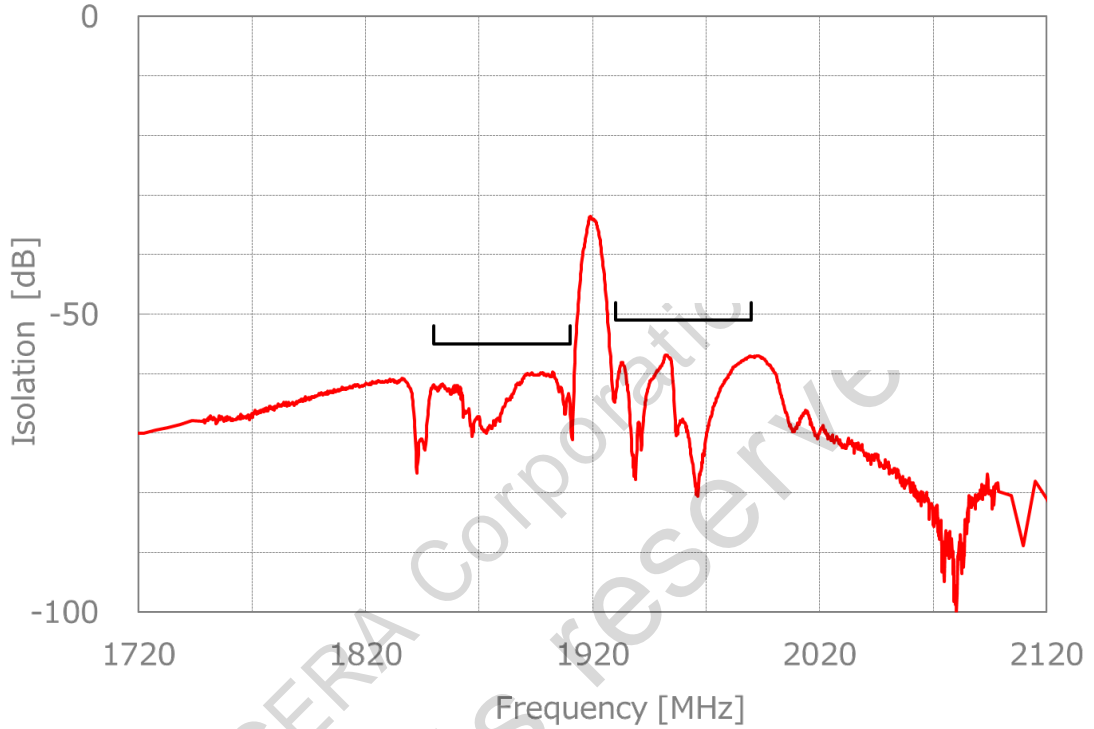

Electrical Characteristics

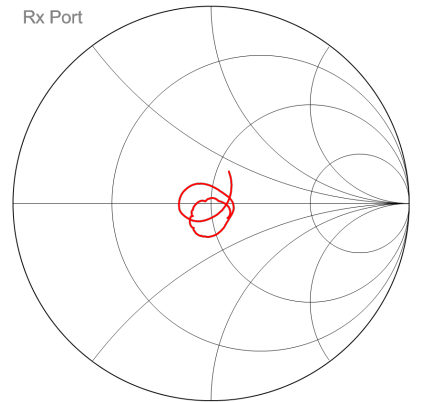
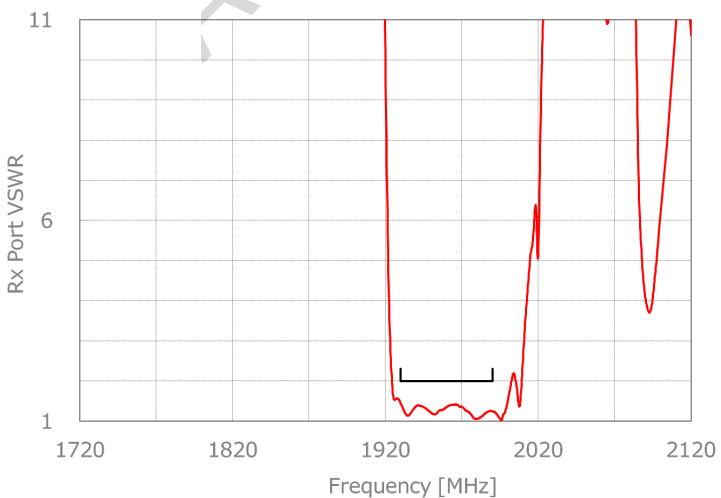
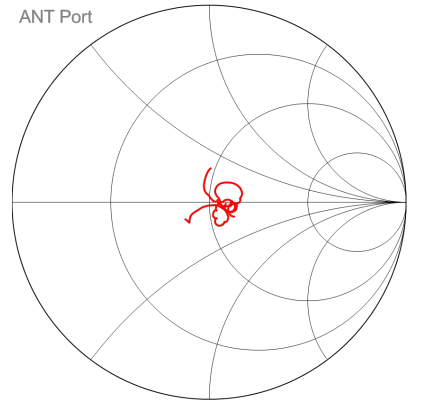
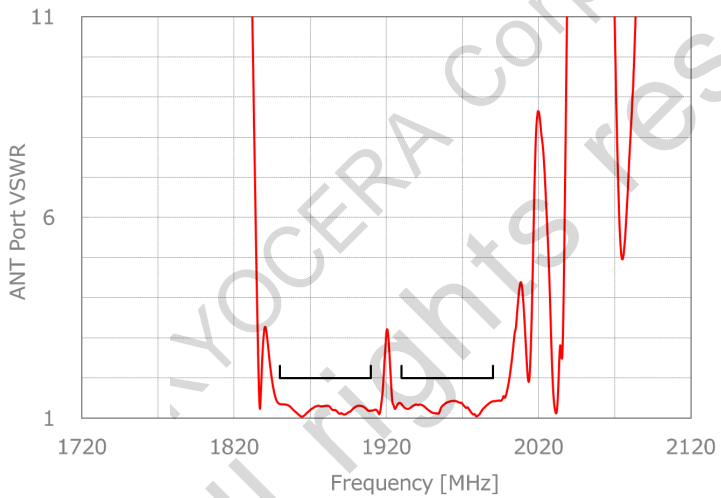
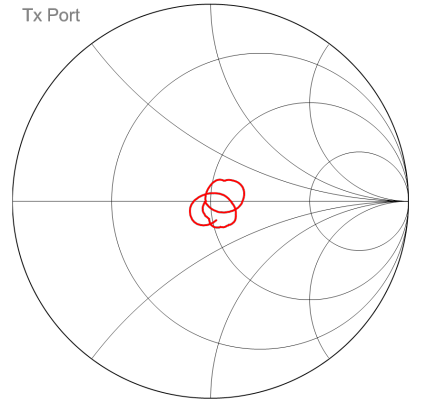
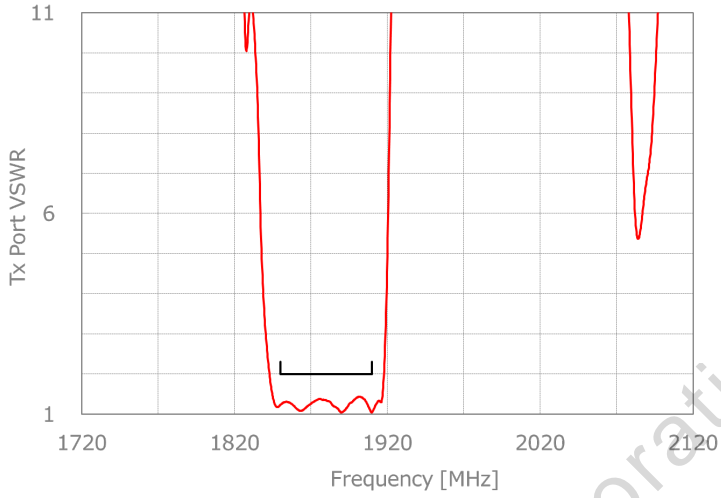

Tape & Reel Specification

[Tape]

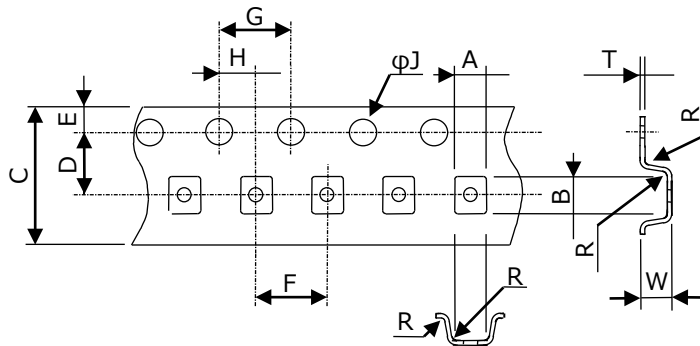

Unit : mm

Part	Dimension
A	1.35±0.10
B	1.80±0.10
C	8.0±0.2
D	3.50±0.05
E	1.75±0.10
F	4.0±0.1
G	4.0±0.1
H	2.00±0.05
φJ	1.5+0.1/-0
R	0.2 Max
W	0.8±0.2
T	0.20±0.05

W : Dimension is depth of pockets.

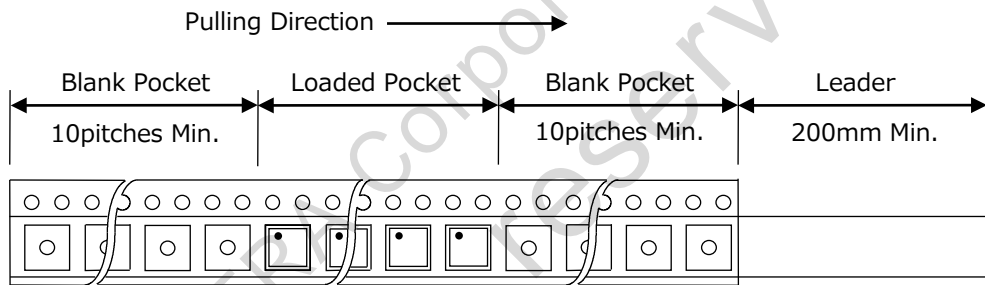

[Reel]

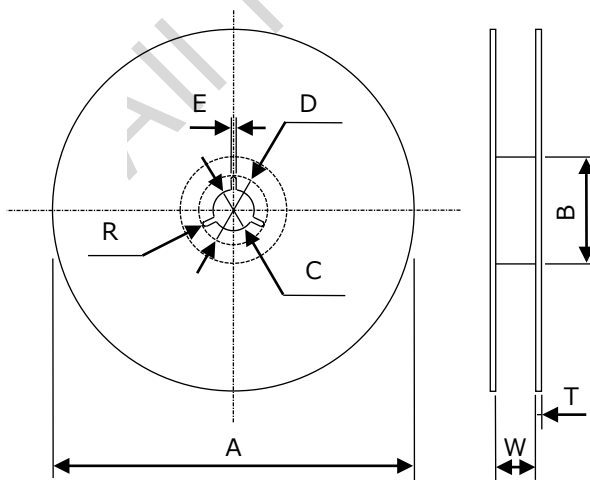

Unit : mm

Part	Dimension
A	330 ± 2
B	100 ± 2
C	13.0 ± 0.2
D	21.0 ± 0.8
E	2.0 ± 0.5
R	1
W	9.5 ± 1.0
T	2.0 ± 0.2

Notice

1. Characteristics described in this datasheet are for references specifications shall be based on written documents agreed by each party.
2. Contents in this datasheet are subject to change without notice. It is recommended to confirm the latest information at the time of usage. Also, this datasheet is revised once a year. We may not be able to accept requests based on old datasheets.
3. Products in this datasheet are intended to be used in general electronic equipment such as office equipment, audio and visual equipment, communication equipment, measurement instrument and home appliances. It is absolutely recommended to consult with our sales representatives in advance upon planning to use our products in applications which require extremely high quality and reliability such as aircraft and aerospace equipment, traffic systems, safety systems, power plant and medical equipment including life maintenance systems.
4. Even though we strive for improvements of quality and reliability of products, it is requested to design with enough safety margin in equipment or systems in order not to threaten human lives directly or damage human bodies or properties by an accidental result of products.
5. It is requested to design based on guaranteed specifications for such as maximum ratings, operating voltage and operating temperature. It is not the scope of our guarantee for unsatisfactory results due to misuse or inadequate usage of products in the datasheet.
6. Operation summaries and circuit examples in this datasheet are intended to explain typical operation and usage of the product. It is recommended to perform circuit and assembly design considering surrounding conditions upon using products in this datasheet.
7. Technical information described in this datasheet is meant to explain typical operations and applications of products, and it is not intended to guarantee or license intellectual properties or other industrial rights of the third party or Kyocera.
8. Trademarks, logos and brand names used in this datasheet are owned by Kyocera or the corresponding third party.
9. Certain products in this datasheet are subject to the Foreign Exchange and Foreign Trade Control Act of Japan, and require the license from Japanese Government upon exporting the restricted products and technical information under the law. Besides, it is requested not to use products and technical information in the datasheet for the development and/or manufacture of weapons of mass destruction or other conventional weapons, nor to provide them to any third party with the possibility of having such purposes.
10. It is prohibited to reprint and reproduce a part or whole of this datasheet without permission.