



Diode Module

K05DD150P080AAA

特徴

Feature

- RoHS 指令準拠
RoHS Compliant

用途

Application

- 一般整流用
For General Use



外形図

Outline Drawing

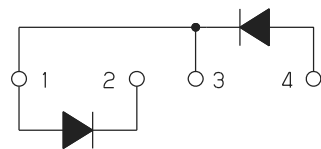
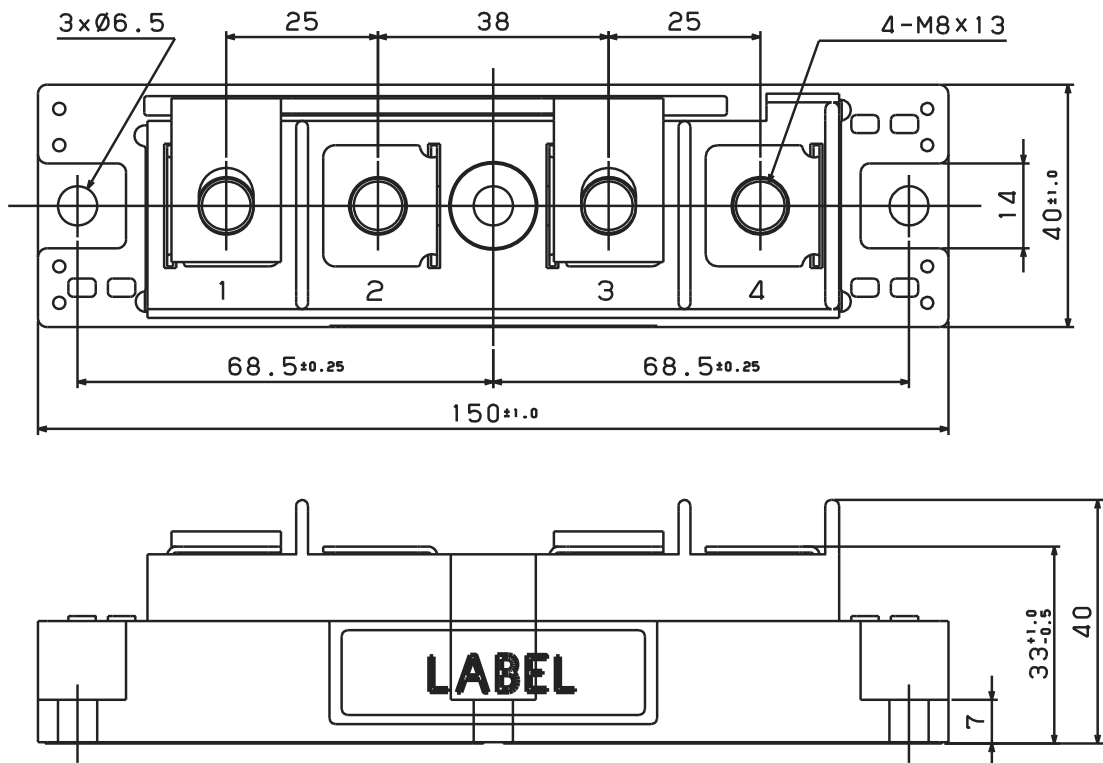

回路構成 Circuit Schema

【単位：mm】

最大定格 Maximum Ratings

項目 Parameter	記号 Symbol	耐圧クラス Grade		単位 Unit
		K05DD150P080AAA		
くり返しピーク逆電圧 *1 Repetitive Peak Reverse Voltage	V _{RRM}	800		V
非くり返しピーク逆電圧 *1 Non Repetitive Peak Reverse Voltage	V _{RSM}	900		V

項目 Parameter	記号 Symbol	条件 Conditions	定格値 Max. Rated Value	単位 Unit		
平均整流電流 *1 Average Rectified Output Current	I _{O (AV)}	商用周波数 180° 通電 Tc=119°C Half Sine Wave	150	A		
実効順電流 *1 RMS Forward Current	I _{F(RMS)}		235	A		
サージ順電流 *1 Surge Forward Current	I _{FSM}	50Hz 正弦半波, 1 サイクル, 非くり返し Half Sine Wave, 1Pulse, Non-Repetitive	3200	A		
電流二乗時間積 *1 I Squared t	I ² t	2~10ms	51200	A ² s		
動作接合温度範囲 Operating Junction Temperature Range	T _{jw}		-40 ~ +150	°C		
保存温度範囲 Storage Temperature Range	T _{stg}		-40 ~ +125	°C		
絶縁耐圧 Isolation Voltage	Viso	端子-ベース間, AC 1 分間 Terminal to Base, AC 1min.	2500	V		
締付トルク Mounting Torque	ベース部 Base	F	サーマルコンパウンド塗布 Greased	M6	2.5 ~ 3.5	N·m
	主端子部 Terminal			M8	9.0 ~ 10.0	N·m

電気的特性 Electrical Characteristics

項目 Parameter	記号 Symbol	条件 Conditions	特性値 (最大) Maximum Value	単位 Unit	
ピーク逆電流 *1 Peak Reverse Current	I _{RM}	T _j =150°C, V _{RM} =V _{RRM}	7	mA	
ピーク順電圧 *1 Peak Forward Voltage	V _{FM}	T _j = 25°C, I _{FM} = 450A	Terminal	1.26	V
			Chip	1.17	
	V _(FO) *2	T _j =150°C	0.77	V	
	r _f *2	T _j =150°C	0.72	mΩ	
熱抵抗 *1 Thermal Resistance	R _{th(j-c)}	接合部-ケース間(Tc 測定点: チップ直下) Junction to Case	0.16	°C/W	
接触熱抵抗 *1 Thermal Resistance	R _{th(c-f)}	ケース-フィン間, サーマルコンパウンド塗布 Case to Fin, Greased	0.1	°C/W	

質量 --- 約 450g Approximate Weight

*1 : 1 アーム当りの値 Value Per 1 Arm. *2 : V_F ≙ V_(FO) + I_F × r_f For power-loss calculation only

順電圧特性
FORWARD CURRENT VS. VOLTAGE

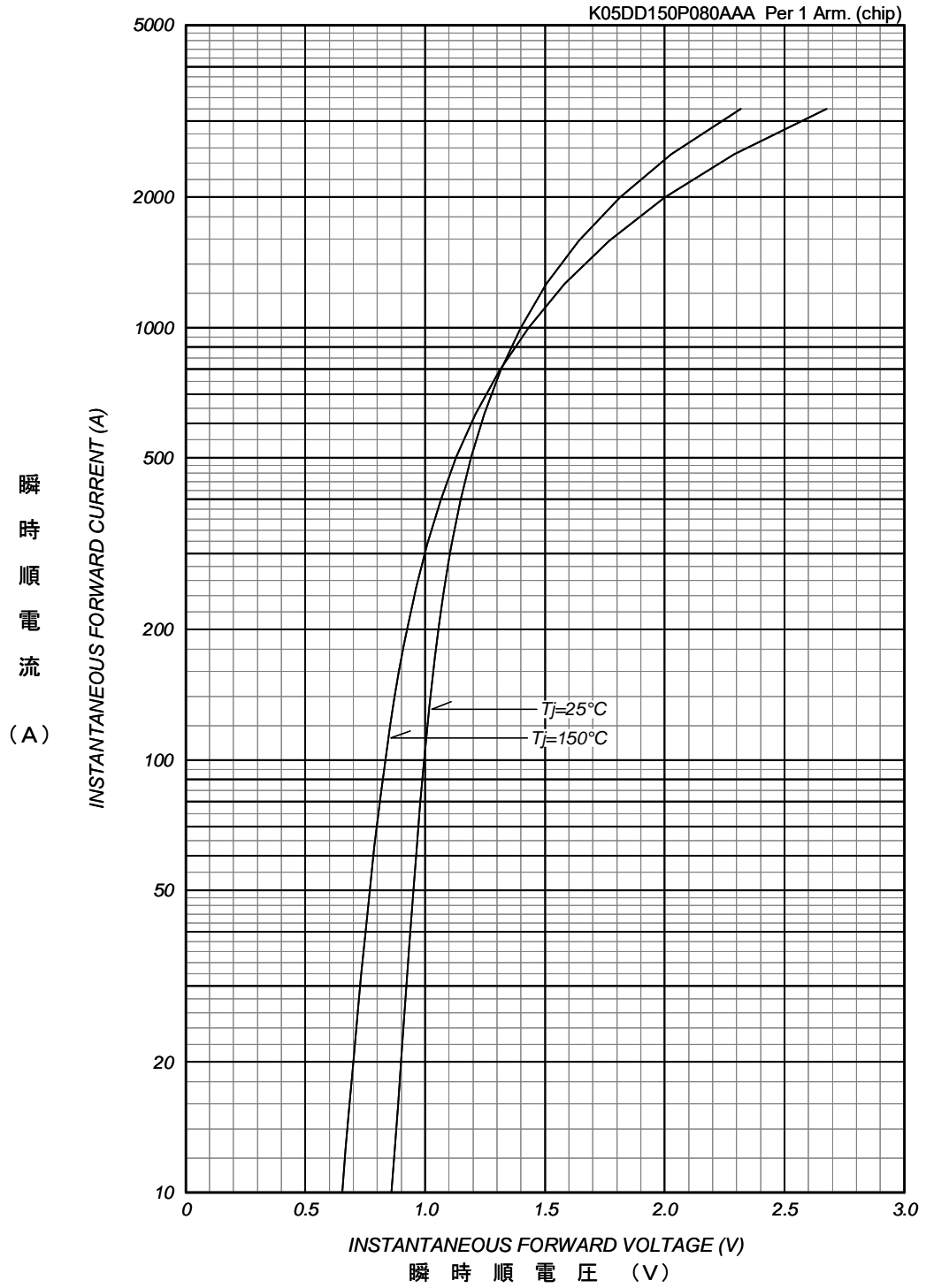

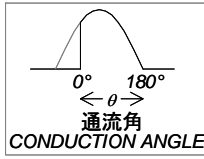

平均順電力損失特性
 AVERAGE FORWARD POWER DISSIPATION

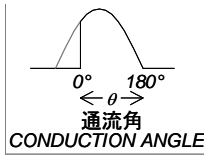
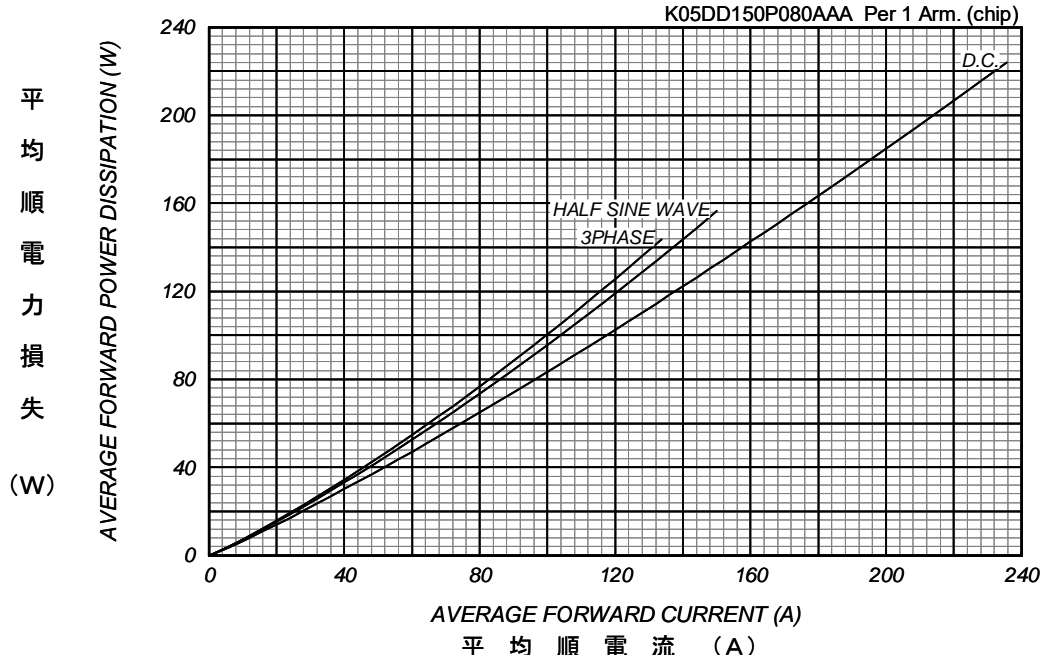

平均順電流 - ケース温度定格
 AVERAGE FORWARD CURRENT VS. CASE TEMPERATURE

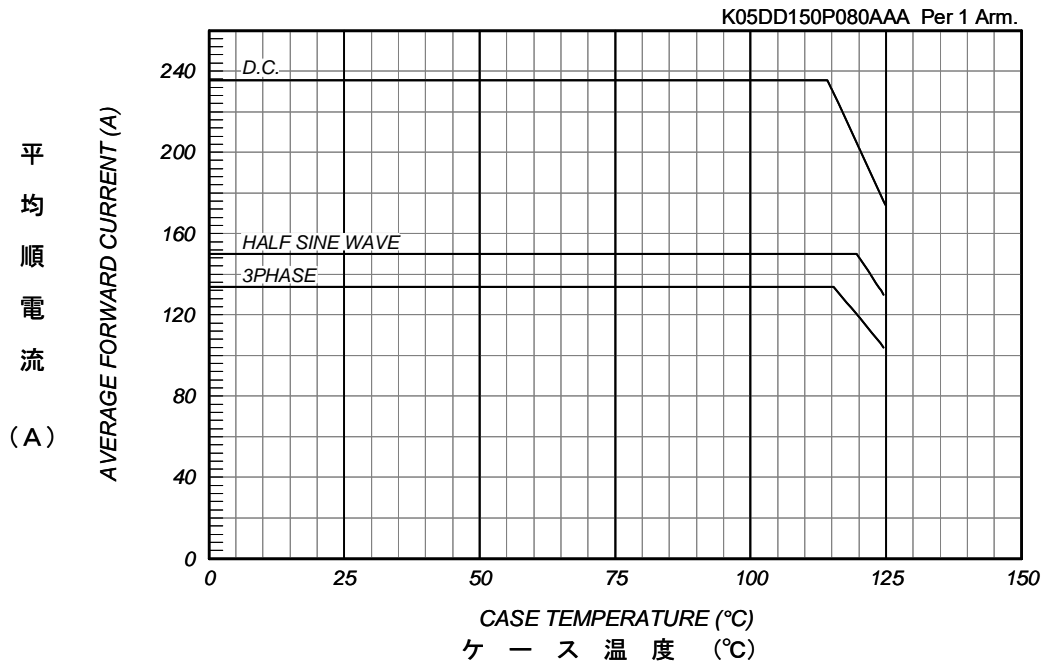

サージ順電流定格
SURGE CURRENT RATINGS

f=50Hz, Half Sine Wave, Non-Repetitive, Tj=150°C

K05DD150P080AAA Per 1 Arm.

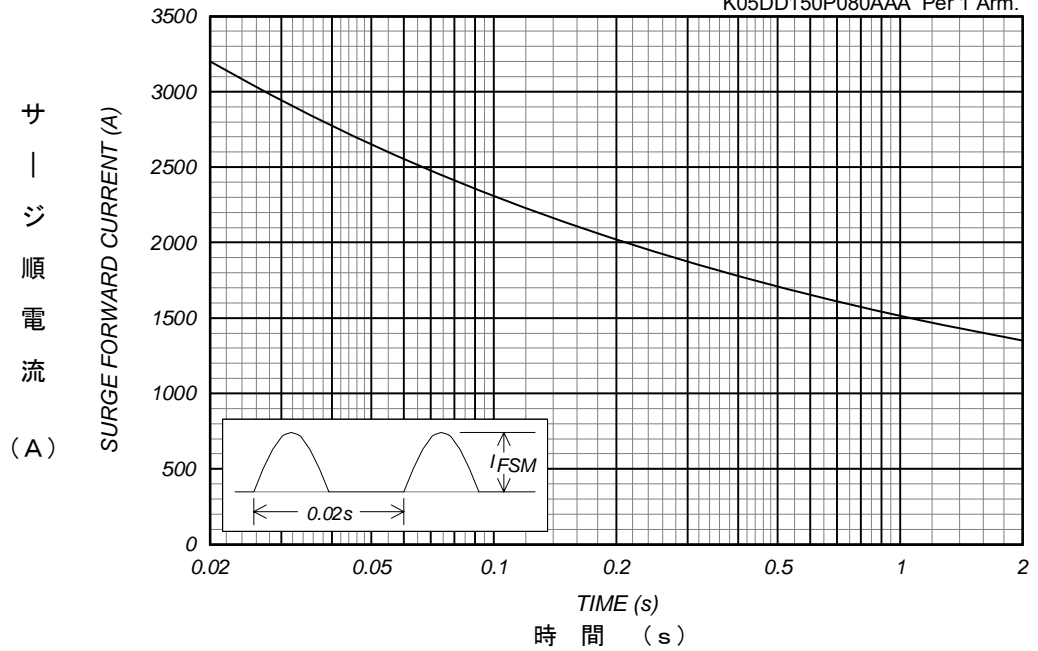

過渡熱抵抗特性
Transient Thermal Impedance

K05DD150P080AAA Per 1 Arm.

